

Injection system for the SIBERIA-2 storage ring

G.Erg, A.Evstigneev, V.Korchuganov, G.Kulipanov, E.Levichev,
Yu.Matveev, A.Philipchenko, L.Schegolev and V.Ushakov
Institute of Nuclear Physics 630090 Novosibirsk, Russia

Abstract

A single-turn injection scheme with two kickers and one septum was proposed to be used for injection into SIBERIA-2. The incoming 450 MeV electron beam from the SIBERIA-1 storage ring is injected with 20 degrees horizontally. The fast kickers generate electromagnetic pulses with rise and down time of 3 ns and a flat top of 15 ns duration. The septum magnet provides a pulse of magnetic field about 100 μ s duration with 20 kG amplitude. This report shows the injection scheme, the design of 450 MeV transfer line and injection equipment. The results of the relevant tests of septum and kickers are discussed.

I. INTRODUCTION

The injection part of the SIBERIA-2 consists of a 80 MeV electron linear accelerator, a 450 MeV booster storage ring SIBERIA-1 and two electron transfer lines - TL-1 and TL-2 [1]. In November-December of 1992 the linac and SIBERIA-1 were commissioned and now the work is continued with the 450 MeV electron beam in SIBERIA-1. SIBERIA-1 operates in single-bunch mode and the stored current is supposed to be 100 mA. The ejected 450 MeV beam has the energy spread $\sigma_E/E = 3.9 \times 10^{-4}$, the bunch length is $\sigma_s = 30$ cm and its horizontal emittance is $\epsilon = 8.6 \times 10^{-5}$ cm-rad.

The ejected electrons are transferred from the midplane of SIBERIA-1 to the midplane of SIBERIA-2 by means of the 20° vertical bending magnet of TL-2. Then after two 20° horizontal bends the electron beam comes to the SIBERIA-2 septum magnet. To match the optics of SIBERIA-1 and SIBERIA-2 eight quadrupole lenses are used. There are also four vertical and two horizontal correctors to control the trajectory in TL-2. To prevent the SIBERIA-2 vacuum deterioration the Be-foil of the 100 μ m thickness is installed at the end of TL-2. Fig. 1 shows the electron beam sizes along the transfer line TL-2.

SIBERIA-2 is designed to be capable of operating both in the 100 mA single-bunch mode and in the 300 mA multi-bunch mode. A maximum possible bunch number is equal

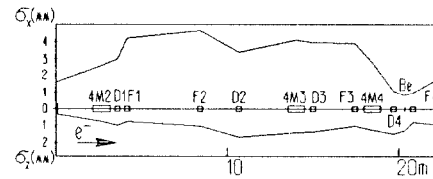

Figure 1: The electron beam sizes in TL-2.

to 30. The injection procedure is repeated with a frequency given by the booster, the storage ring SIBERIA-1. The expected rate of current storage for a circulation of about 100 mA is roughly equal to 10-20 min. Table 1 shows the injection parameters of the stored beam for the septum azimuth.

Table 1
SIBERIA-2 (450 MeV and 100 mA single bunch mode)

Revolution frequency f_o , MHz	2.465
Harmonic number q	75
RF wavelength λ_o , m	1.655
Damping times τ_x, τ_z, τ_s , sec	0.52, 0.54, 0.26
Emittances ϵ_x, ϵ_z , cm-rad	$34 \times 10^{-6}, 3.4 \times 10^{-6}$
Beam sizes $\sigma_x, \sigma_z, \sigma_s$, cm	0.25, 0.05, 2.7
Beam life time (Touschek), hr	0.7

II. INJECTION

For the SIBERIA-2 storage ring the injection scheme was chosen to be horizontal with one prekick of the stored beam and one kick of the injected and stored beams, Fig.2. The SIBERIA-2 lattice comprises six mirror-symmetrical su-

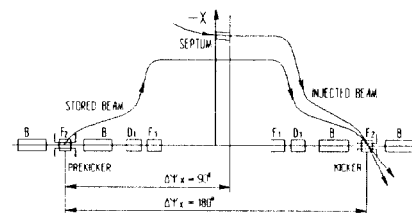

Figure 2: The layout of storage ring injection scheme.

perperiods with achromatic bends. All injection devices are located inside the achromatic bend. Due to the achromatic bend the horizontal betatron phase

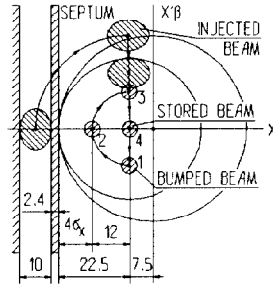

Figure 3: The injection horizontal phase space.

advance from the center of a superperiod to the center of the quadrupole F2 does not depend on the betatron tune and is always equal to $\pi/2$. A prekicker and a kicker are housed inside the vacuum chamber of lenses F2 with the π -phase advance between them.

Prior to the injection the prekicker deflects the stored beam (the maximum angle is equal to 5 mrad) in parallel to the equilibrium orbit at 1.25 cm towards the septum knife. The kicker dumps the deviation of the stored and injected beams. The kickers location permits us to use more effectively the ring horizontal acceptance and to dump the deviation of the stored beam rather precisely, that is important for the storing in the single-bunch mode.

Fig. 3 shows the injection scheme in normalized horizontal phase space. In the case, when the kick is equal to the prekick, the needed horizontal aperture is

$$X = (A_x \beta_{x0})^{1/2} = 4\sigma_x + t + 2a_x = 22.5 \text{ mm},$$

where $4\sigma_x = 10.1$ mm is a distance between the deflected orbit and the septum, $t = 2.4$ mm is the total septum knife thickness, $2a_x = 10$ mm is the septum aperture, A_x is the required acceptance and $\beta_{x0} = 17$ m is the amplitude function at the septum azimuth.

Really we have $X = 30$ mm that satisfies both the injection condition and good lifetime requirement of a 100 mA single-bunch mode at 2.5 GeV. At the injection we need a lower aperture, therefore to reduce the kickers voltage we will switch on two horizontal steering magnets combined with quadrupoles F2. The steering magnets will shift equilibrium orbit towards the septum at a distance of 7.5 mm. The expression for X is independent of the injected beam emittance ($\epsilon_x = 8.6 \times 10^{-5} \text{ cm-rad}$), because it is expected to be considerably less than the storage ring acceptance ($A_x = 3.0 \times 10^{-3} \text{ cm-rad}$).

III. SEPTUM MAGNET

The septum bends the 450 MeV electrons at an angle of 20° in horizontal plane and injects them into the storage ring chamber at the azimuth of quadrupole focusing lens F1. The main septum parameters are as follows: the field

amplitude 2 T, the horizontal aperture 10 mm, the vertical aperture 14 mm, the total azimuth length 0.294 m and the bending radius 0.75 m.

The compact pulse septum has been designed and manufactured according to the initial requirements:

- to operate in the high vacuum conditions at the pressure as low as $1 \div 0.1$ nTorr and to be heated in situ up to 400°C ,
- to have a low leakage magnetic flux to avoid the distortion of the circulating beam,
- to have high mechanical strength and high stability of the pulse field amplitude.

The septum has been made of copper. The septum electrical scheme is system of the three conductors shorted out at one of the ends, Fig.4. Another end is connected to the 300 V voltage output of a pulse transformer, fed by a 7

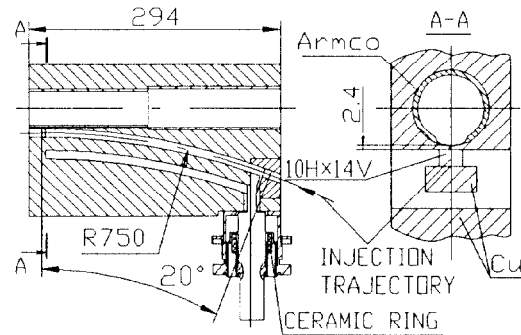

Figure 4: The cross sections of the septum.

kV pulse generator. The available pulse repetition rate is 0.1 Hz. The parallel skin currents induce a magnetic field on the injected beam trajectory being passed between the central and external conductors.

The magnetic forces of about 1.5 t act on the central bus in the opposite directions. The good dynamical balance of the central bus was attained by its symmetrical position relative to lateral buses.

The septum is housed in the vacuum tank. The outward metal surfaces of the septum are welded to the vacuum tank steel wall. To separate the vacuum volume from the outside atmosphere a ceramic ring was installed between the inner and outer cylindrical surfaces of the septum electrical input.

The septum inductance is $0.053 \mu\text{H}$. The half-sine current pulse in the central bus has an amplitude of 180 kA. The pulse duration is chosen to be equal to $100 \mu\text{s}$. The corresponding skin thickness in copper is 0.93 mm, that is less than the 2 mm thickness of the copper part of the knife. According to our estimation, in this case the magnetic field penetrating through the metal in the stored beam direction falls off to $2 \div 5\%$ of its maximum value.

To screen very reliably the storage ring aperture from the remaining long-lived leakage field a 3 mm ARMCO tube was inserted into the vacuum chamber and joined with the copper surface by means of diffusion welding. The lowest magnetic screen thickness is equal to 0.4 mm at the

knife, so the total knife thickness is 2.4 mm. The fringing field existing close to the opened septum exit is nearly suppressed by the 20 mm long exit hole.

According to the measurements the reproducibility of the septum magnetic field from pulse to pulse is $\leq 2 \times 10^{-4}$. During the tests there was no any vacuum deterioration because of the ceramic ring failure. Fig.5. shows the measured longitudinal distribution of the septum magnetic field. The measured effective length is equal to 252.6 mm

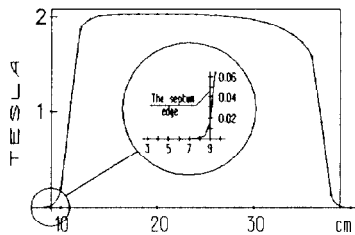

Figure 5: The measured longitudinal distribution of the septum magnetic field

instead of the calculated 261.8 mm. This difference is quite permissible. The sharply reduced fringing field is no more than 0.1 % of the maximum value at a distance of 2 mm from the septum exit. So the measured leakage magnetic field integral in the storage ring aperture is much less than the 200 Gs-cm tolerance.

IV. NANOSECOND KICKERS AND GENERATORS

The requirements to be satisfied when designing the kicker were the following:

- high voltage amplitude is no more than 60 kV,
- wave impedance 50 Ohm,
- the relative deviation of the electric field inside the aperture is as low as 5%,
- the gap equals 25 mm and the kicker length is 500 mm,
- each kicker plate has a longitudinal slit of 8 mm height to avoid its heating by synchrotron radiation and to reach the field symmetry.

The kicker layout is shown in Fig.6. The 5% field homo-

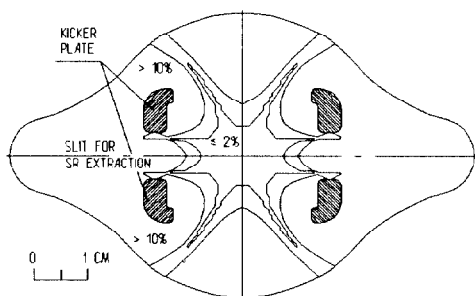

Figure 6: The calculated transverse field distribution of the kicker.

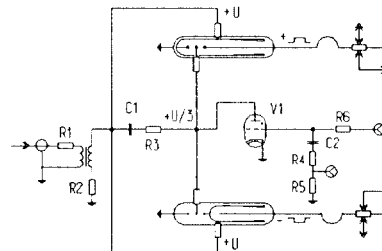

Figure 7: The scheme of the bipolar nanosecond generator.

geneity corresponds to the apertures $2X = 12$ mm and $2Z = 14$ mm. It is quite sufficient for injection.

The kickers are fed by the bipolar high voltage nanosecond generators and operate in the travelling wave mode. The scheme of the bipolar generator is shown in Fig.7. The generator operates on the basis of the fast discharge of double forming lines which are connected to the kickers by nitrogen filled coaxial cables. The discharge is realized by a gaseous spark gap (the so-called 3-electrode discharger). The discharge is initiated by a thyatron connected to the central electrodes of the dischargers. The discharge moment is tuned by varying the pressure of nitrogen inside the electrode volume. The pulse duration is equal to doubled propagation time of electromagnetic wave travelling along the forming line.

In the case of high amplitude nanosecond pulse, the double forming line has the following advantages in comparison with the single forming line: it enables one to reduce twice the charging voltage and to simplify the scheme of the generator, because this makes it possible to give up the inverters for producing the pulses of opposite polarities. The nanosecond generators were manufactured and tested.

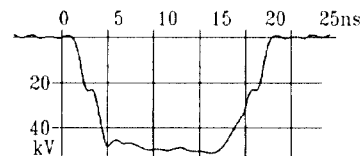

Figure 8: The typical kicker pulse oscillogram.

Fig.8 shows the typical oscillogram of the high voltage pulse at the kicker plate. The pulse parameters are: the duration is equal to 20 ns with the edges as sharp as 5 ns and voltage amplitude up to 50 kV. The rms time spread of the moments when the signal comes to the kicker plates is about 1 ns.

REFERENCES

[1] V.V.Anashin et al., Nucl. Instr. and Meth. A282 (1989) 369-374