

## Application of Synchrotron Radiation for Studying Detonation and Shock-Wave Processes

A. N. Aleshaev,<sup>1</sup> P. I. Zubkov,<sup>2</sup> G. N. Kulipanov,<sup>1</sup>  
L. A. Luk'yanchikov,<sup>2</sup> N. Z. Lyakhov,<sup>3</sup> S. I. Mishnev,<sup>1</sup>  
K. A. Ten,<sup>2</sup> V. M. Titov,<sup>2</sup> B. P. Tolochko,<sup>3</sup>  
M. G. Fedotov,<sup>1</sup> and M. A. Sheromov<sup>1</sup>

UDC 534.222.2 + 662. 217

Translated from *Fizika Goreniya i Vzryva*, Vol. 37, No. 5, pp. 104–113, September–October, 2001.  
Original article submitted November 16, 2000.

**A new method of remote investigation of detonation and shock-wave processes with the use of synchrotron radiation is proposed. The facility used for the first experiments with measurement of density and small-angle x-ray scattering in detonation of condensed explosives is described. The high time and spatial resolution of the techniques proposed allows one to determine the character and mechanism of destruction of the condensed phase and the growth dynamics of new structures, including crystalline ones, in detonation flows. The capabilities of the new technique are described.**

### INTRODUCTION

X-ray radiation has been frequently and successfully used in static measurements to determine the boundaries of substances with different absorbing capacities. It is also widely used in structural analysis. The capabilities of x-ray techniques have been significantly extended with the development of principally new sources of radiation — bunches of electrons moving in accelerators along closed trajectories. Such radiation was called synchrotron radiation (SR). Synchrotron radiation has the following advantages over the classical sources of radiation, where x-ray quanta are generated by deceleration of electrons accelerated by an electric field during interaction of electrons with a metallic anode:

- small angular divergence ( $\alpha = 10^{-3}$ – $10^{-5}$  rad) with a high flux intensity [ $\approx 10^{16}$ – $10^{21}$  photons/(sec·cm<sup>2</sup>)];
- generation of radiation pulses following each other with a stable time interval (5–1200 nsec) for a long time;
- small duration of the radiation pulse (less than 1 nsec);
- wide spectral range of radiation (4–100 keV).

These SR properties have allowed measurements in dynamic experiments with results of interaction between radiation and substances registered at sequential instants of time. Obviously, as the registration time decreases, it is necessary to use more and more sensitive and fast-response detectors of x-ray radiation. Requirements to the necessary power of radiation become higher. At the Institute of Nuclear Physics of the Siberian Division of the Russian Academy of Sciences, the millisecond range of measurements was conquered by 1977. By 1998, the sources of radiation and detectors were improved to an extent that it became possible to reduce the registration time by several orders of magnitude. To implement the new capacities, a program is currently executed, which is aimed at development of a technique for diagnostics of detonation waves with the

<sup>1</sup>Budker Institute of Nuclear Physics,  
Siberian Division, Russian Academy of Sciences,  
Novosibirsk 630090.

<sup>2</sup>Lavrent'ev Institute of Hydrodynamics,  
Siberian Division, Russian Academy of Sciences,  
Novosibirsk 630090.

<sup>3</sup>Institute of Chemistry of Solids and Mechanochemistry,  
Siberian Division, Russian Academy of Sciences,  
Novosibirsk 630128.

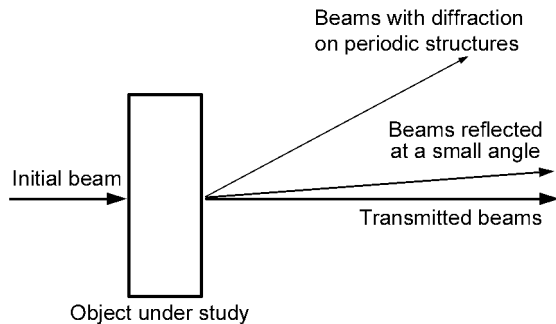


Fig. 1. Transmission of radiation through the object.

use of SR. This choice was based on the following factors:

- high rate of variation of the detonation-wave parameters in space and in time, which necessitates measurements in the nanosecond range of time;
- possibility of stable reproduction of the process;
- availability of preliminary information on gas dynamics of the flow and phase transitions in detonation waves.

When radiation is incident onto an object under study (Fig. 1), part of radiation is absorbed by the substance itself. The beam passing without deflection has the greatest intensity and bears information on changing density of the substance. The beams deflected by a small angle bear information on fluctuation of the electron density in the registration zone. The intensity of these beams is already several orders higher. Finally, the third type of beams, diffracted radiation, has an even lower intensity and bears information on the parameters of periodic structures in the substance.

The experimental results described in the present paper refer to transmitted beams and beams deflected by a small angle (small-angle x-ray scattering — SAXS). Small-angle scattering arises only if considerable fluctuations of density are formed in the registration zone. In carbon-containing high explosives (HE), these fluctuations may be caused by the synthesis of ultradispersed diamonds (UDD). The latter process has been rather intensively studied, and the literature contains rather comprehensive information on synthesis parameters, which was mainly obtained by studying the final products remaining in blasting chambers [1].

The use of SR allows the real-time study of detonation processes, including the UDD formation dynamics.

## PARAMETERS OF SYNCHROTRON RADIATION

The main parameters of the storage ring of electron accelerators are the radius of the orbit of electron motion  $R$  (generally, 10–30 m), the energy of electrons  $E$  (1–5 GeV), the induction of the magnetic field in rotary magnets  $B$  (1–7 T) and the number of the latter, and also the electron current  $I$  (100–400 mA). These parameters are linked by the following relationships:

$$R = E/eB, \text{ where } e \text{ is the electron charge;}$$

$$I = eN_e c/2\pi R, \text{ where } c \text{ is the velocity of light and } N_e \text{ is the number of electrons in the beam.}$$

Stability of the electron beam in the ring depends on the quality of vacuum in the channel and may reach several hours to several dozens of hours. The parameters of the storage ring are responsible for the characteristics of the generated synchrotron radiation. The spectral composition of SR is usually described by the critical wavelength  $\lambda_{cr}$ , which is chosen in such a way that the total SR energy radiated by the source at all wavelengths higher than the critical one is equal to the energy radiated at lower wavelengths. SR intensity is characterized by spectral brightness defined as the ratio of the number of photons within the photon energy range (ER) from  $E_{ph}$  to  $E_{ph} + \Delta E_{ph}$  (generally,  $\Delta E_{ph} = 0.1\% E_{ph}$  is chosen, the so-called 0.1% ER) emitted per 1 sec to the unit area of the surface of the radiating region and unit solid angle of divergence of the photon beam. Thus, this quantity has the dimension of photon/(sec · mm<sup>2</sup> · rad<sup>2</sup> · 0.1% ER). The dimensional characteristics of the SR source are determined by emittance, which is a quantity equal to the product of the linear size of the emitting region of the electron beam and the divergence angle of the SR beam. Typical values of the vertical and horizontal emittance of modern SR sources are 10<sup>-10</sup>–10<sup>-8</sup> and 10<sup>-8</sup>–10<sup>-6</sup> m · rad, respectively.

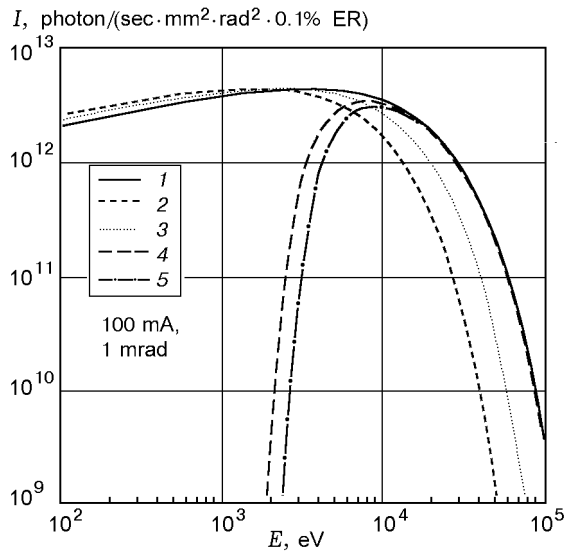
The total power  $W$  radiated by the electron beam per one revolution on the orbit and the critical wavelength  $\lambda_{cr}$  are determined by the electron energy in the beam, the electron current, and the radius of the orbit:

$$W \sim I\gamma^4/R$$

( $\gamma$  is the Lorentz factor of the electron  $\gamma = E/m_0c^2$ , where  $m_0$  is the electron mass at rest),

$$\lambda_{cr} = 4\pi R/3\gamma^3.$$

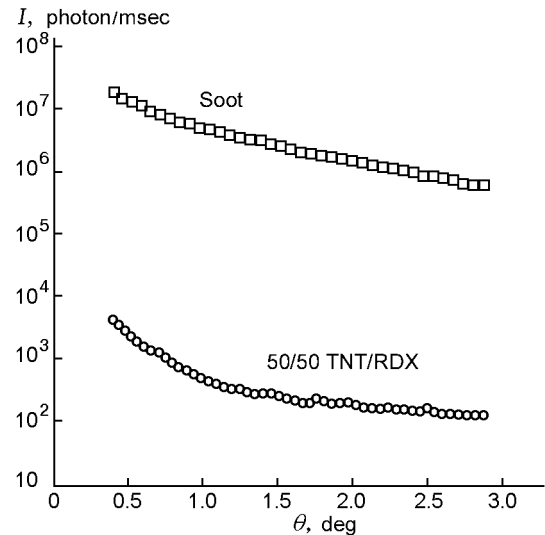
For SR generation, the existing electron storage units have special devices, which are not necessary el-



**Fig. 2.** Spectral flux of SR ( $I$ ) versus the induction  $B$  of the magnetic field of the wiggler for VEPP-3: curves 1–3 refer to  $B = 4.4, 2,$  and  $3$  T, respectively; curves 4 and 5 refer to beryllium windows  $0.6$  and  $1$  mm thick, respectively, for  $B = 2$  T.

elements of the ring but allow obtaining SR with directionally modified characteristics as compared to radiation from a rotary magnet. The main types of these devices are undulators and wigglers. An undulator is a system of permanent magnets with regularly alternating poles; the motion of electrons in these devices may be considered as oscillations around the initial straight-line trajectory. The use of undulators allows one to increase the brightness of the source by two or three orders and also to reduce the beam size (i.e., to reduce the emittance). In addition, under certain constructional features of the undulator, a significant fraction of the emitted energy can be concentrated in several narrow spectral bands — undulator harmonics (whose wavelengths can be also varied by choosing appropriate magnetic parameters of the undulator), which allows one to reach an even higher intensity at these wavelengths. The radiation spectrum for the ring of an accelerator on colliding electron-positron beams (VEPP-3) is shown in Fig. 2 as a function of the magnetic field induction  $B$  of the wiggler. The lower boundary of the SR spectrum is determined by the output-window material and reaches  $\approx 3\text{--}4$  keV if beryllium is used. A wiggler with induction  $B = 2$  T was used in the experiments described below.

Moving over the storage ring, the electrons are divided into several bunches 3–30 cm long. For this reason, the electron current through the wiggler is not continuous. Thus, synchrotron radiation consists of periodic bursts (pulses) with duration of several dozens



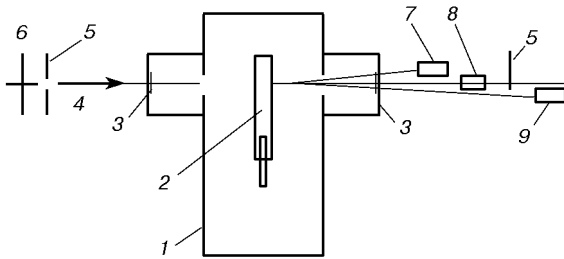
**Fig. 3.** Dependence of SAXS signals ( $I$ ) for cast 50/50 TNT/RDX and its soot on the angle of observation of scattered radiation ( $\theta$ ).

of picoseconds more and with an interval between the pulses from 5 nsec to  $1.2 \mu\text{sec}$ . Under certain conditions of accumulation, it is possible to reach a regime with only one bunch of electrons moving over the ring. In this regime, the SR pulse duration (1 nsec) and the interval between the pulses ( $\Delta t = 250$  nsec for VEPP-3) are rather regular.

### TEST EXPERIMENTS WITH THE SOOT

The possibility of using SR for studying explosive processes was first verified by SAXS registration under static conditions from detonation products of the 50/50 TNT/RDX (soot), which were preserved in an inert gaseous medium. According to [1], the amount of soot in 50/50 TNT/RDX is  $\approx 9\%$  of the HE mass and contains up to 80% of UDD. The soot sample subjected to SR was a cylinder 10 mm in diameter and 40 mm long, in which soot was uniformly mixed with paraffin (6% soot + 94% paraffin by mass).

SAXS was registered by a one-coordinate x-ray detector. Simultaneously, SAXS from a 50/50 TNT/RDX charge of the same size was registered. The results of these experiments are plotted in Fig. 3. The integral intensity of SAXS of the products (soot) is higher than the corresponding parameter for the initial sample (50/50 TNT/RDX) by more than three orders of magnitude. The estimates show that this intensity of soot is sufficient to register it during one SR burst, i.e., during 1 nsec. This gives grounds to believe that, during



**Fig. 4.** Layout of the test station: 1) blasting chamber; 2) HE charge being examined; 3) beryllium windows of the blasting chamber; 4) direction of the SR beam; 5) horizontal knives; 6) vertical knives; 7) SAXS gauge within the energy range of 7–15 keV; 8) gauge of transmitted radiation; 9) SAXS gauge within the energy range of 15–30 keV.

the time of the detonation-wave front passing through the zone irradiated by an SR beam, structural changes in the zone of chemical transformations should lead to equally strong changes in SAXS curves, and these changes may be registered during 1 nsec.

### TEST STATION FOR EXPLOSION EXPERIMENTS ON VÉPP-3

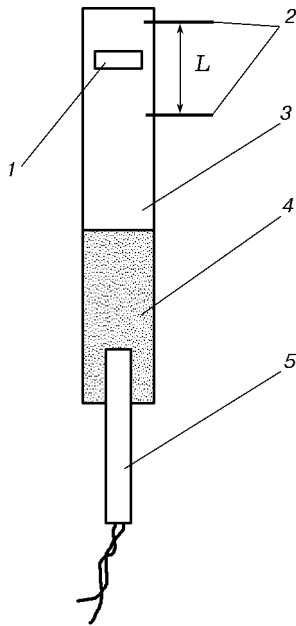
A test station was created to study explosive processes on VÉPP-3 with the use of synchrotron radiation. The test station consists of a specialized blasting chamber designed for explosion of 15 g of an HE, a system of high-voltage initiation of the HE, detectors of x-ray radiation and signal amplifiers, a CAMAC unit for recording signals obtained, a system of adjustment of detectors with respect to the SR beam, and a system of synchronization of the registration equipment with the VÉPP-3 accelerator. The general layout of the test station is shown in Fig. 4.

The blasting chamber is made of stainless steel and has an input window for the SR beam, an output window for the direct beam and scattered radiation, an exhaust channel for output of gases (detonation products), and two taps for connecting to the vacuum system and filling the chamber by gases. Under conditions of minimum losses of x-ray radiation, the input and output windows for SR were made of beryllium 2 mm thick. To ensure leak-proofness of the windows after the explosion, the chamber was equipped by special “dampers” of shock waves. An electromagnetic valve was placed ahead of the input window; it was opened for 20 msec simultaneously with the initiating device. The valve is necessary to protect the HE charge from an intense radiative action.

Registration of transmitted (direct) and diffracted radiation by various detectors was verified and adapted in the course of tests. Experiments on small-angle x-ray scattering required a detector with an acceptable sensitivity within the energy range of 5–30 keV, the area of the sensitive region of greater than 5–10 mm<sup>2</sup>, and operating speed providing independent registration of the burst of x-ray radiation at each revolution of the beam.

By checking the x-ray sensitivity of various semiconductor devices on the basis of silicon and germanium, we chose an FTG-3 germanium phototransistor as a SAXS detector. Germanium pulsed transistors GT321 also possessed suitable parameters, but because of their significantly smaller working area, SAXS was mainly registered by FTG-3 transistors with the maximum sensitivity within the range of 15–30 keV.

To increase the sensitivity of the system and reduce the pulse to a form convenient for registration, a driver amplifier was developed, which ensured the formation of a pulse with duration of  $\approx 100$  nsec. Fast-response 8-digit ADC-850SK were used in experiments. The total number of memory cells in each ADC was 4096, and the total time interval of measurements was 512  $\mu$ sec. Such a long registration time allowed us to trace the evolution of the process under unloading of detonation products to a pressure of  $\approx 2$  atm, which is established in the blasting chamber after the explosion. To compensate for the slow (drift) components of the leakage current of the detector and suppress the low-frequency noise components, the regime of digital double-correlated sampling was used in the experiments, i.e., the signals were measured twice during the beam revolution (at the moments of the pulse maxima and in pauses between them) with subsequent computer processing (by taking the difference between the recorded signals). To register the intensity of the transmitted direct SR beam and the intensity of the “soft” (within the energy range of 7–15 keV) component of SAXS, detector heads with silicon pin-photodiodes and low-noise amplifiers were developed. In such a head, the detector crystal (chip photodiode) of small area (1  $\times$  1 mm) was located at the end of a thin coaxial bar. This allowed precision introduction of the detector into the direct beam (without shading FTG-3) and exact adjustment of the detector outside the beam. An absorbing filter (1–2 mm polyvinylchloride) was placed ahead of the direct-beam detector to reduce sensitivity in the “soft” region (less than 15 keV). In the transmitted direct SR beam, the flux on the detector was  $\approx 10^4$  photons/burst. The total flux of diffracted photons registered by FTG-3 was  $\approx 10^3$  photons/burst, and the corresponding value for silicon pin diodes was  $\approx 15$  photons/burst.



**Fig. 5.** Location of the HE charge: 1) zone where the SR beam was introduced; 2) wire gauges; 3) 50/50 TNT/RDX charge; 4) powdered HMX; 5) detonator.

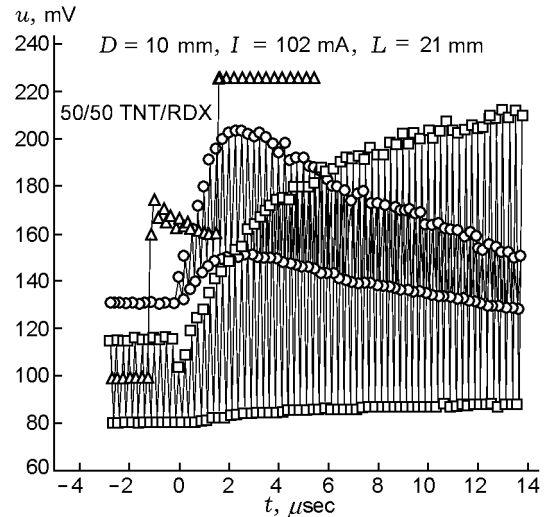
**STATEMENT OF THE EXPERIMENT**

The charge geometry and positions of wire gauges are shown in Fig. 5. The height of the radiation region on the HE charge (the “spot” from the SR beam) was 0.2–1.5 mm, and its width was 5–6 mm. The cast and powdered charges had diameters of 10 mm, and the pressed charges were 12.5 mm in diameter. An intermediate charge of powdered HMX was used for reliable excitation of detonation in TNT–RDX and TNT charges. The charge length was varied from 25 to 80 mm. The distance between the wire gauges  $L$  in different experiments was 19–21 mm. Filming of similar charges by an PIR-200 x-ray device showed that the detonation front was rather flat for a charge length greater than 30 mm.

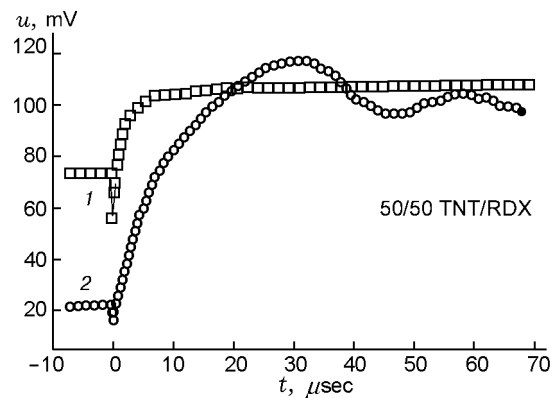
**TEST RESULTS**

**1. Measurement of Transmitted Radiation**

Figure 6 shows the records of SAXS radiation passing through the 50/50 TNT/RDX charge and signals from wire gauges. The measurements were conducted with time intervals  $\Delta t = 250$  nsec, and the “background noise” of the amplifiers was measured in between. Therefore, the valid signal for transmitted radiation and SAXS is obtained as the difference between

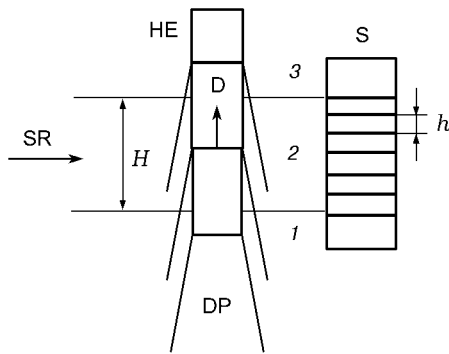


**Fig. 6.** Amplitudes of the signals ( $u$ ) from detectors of transmitted x-ray radiation (curve 1), SAXS (curve 2), and signals from contact gauges (curve 3) versus time  $t$ .



**Fig. 7.** Amplitudes of the signals of germanium (curve 1) and silicon (curve 2) detectors of transmitted radiation versus time.

the upper and lower points. The record clearly shows compression in the detonation front and expansion of detonation products after the explosion. Figure 7 shows transmitted radiation recorded simultaneously by germanium and silicon detectors. The detectors were adjusted in such a manner that the germanium detector registered the “hard” component of radiation (energy range of 20–30 keV), and the silicon detector registered the “soft” component (7–15 keV). The first detector provides high-quality registration of combustion in the detonation front and the initial spread of detonation products, whereas the “soft” component strongly absorbed in the initial HE registers well the final spread of detonation products and propagation of waves in the

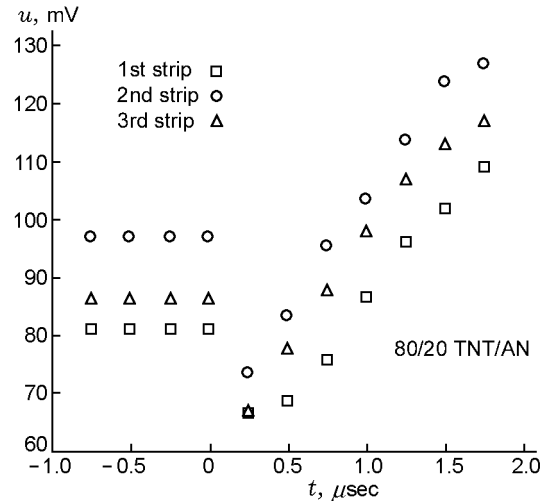


**Fig. 8.** Density measurement by a microstrip detector: SR is the beam direction,  $H$  is the SR beam height, HE is the HE charge, D is the detonation-front direction (1–3 show consecutive positions of the detonation front every 250 nsec), DP is the spreading detonation products, S is the microstrip detector, and  $h$  is the distance between the strips inside the detector.

blasting chamber after their reflection from the walls. The dynamic range of the channel of simultaneous registration of transmitted radiation with the use of several detectors allows one to measure the density from 2 to  $0.002 \text{ g/cm}^3$ .

For the detonation rate obtained ( $D = 7.5 \text{ km/sec}$ ), the linear resolution is  $D\Delta t = 1.875 \text{ mm}$ . The storage device of VÉPP-3 allows a twofold increase in the SR pulse frequency if two bunches of electrons are used. The resolution may be cardinally increased by using an array of detectors (microstrip detector) instead of one detector.

Figure 8 shows the layout of the experiments. If the detonation front is located opposite the detector at the moment of arrival of the SR pulse (position 2), the detector yields an instantaneous distribution of density over the height  $H$ , and the linear resolution is determined by the strip step  $h$ . For the detonation front to arrive necessarily at the detector field S, the SR beam width  $H$  should be greater than the distance between the consecutive positions of the detonation front after a period of SR pulse-repetition frequency (1–3). A 50-channel detector with a step between the strips  $h = 100 \text{ }\mu\text{m}$  was used in the experiments. In this case, the time resolution was  $\Delta t = h/D = 13.3 \text{ nsec}$ . At the first stage, only three channels were used in the experiments (strips spaced by  $400 \text{ }\mu\text{m}$  were connected to three channels of the ADC). Figure 9 shows the record of these three channels in the case of detonation of a pressed charge of 80/20 TNT/AN. For a detector with a strip step  $h = 7.5 \text{ }\mu\text{m}$ , the time resolution is  $h/D = 1 \text{ nsec}$ . In this case, the number of registration channels should be  $1875 \text{ }\mu\text{m}/7.5 \text{ }\mu\text{m} = 250$ .



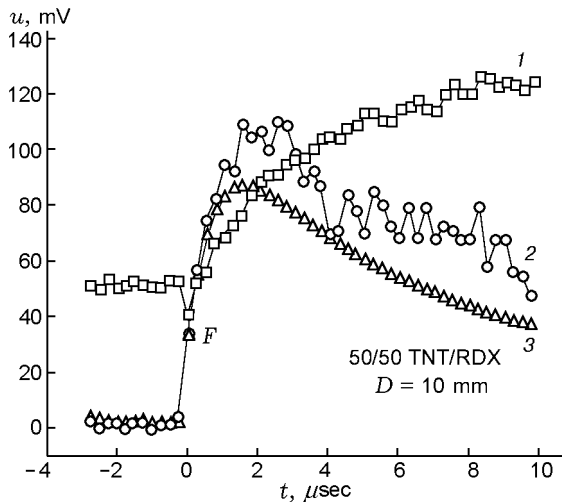
**Fig. 9.** Amplitudes of signals of the microstrip detector versus time (the distance between the strips is  $0.4 \text{ mm}$ ).

## 2. SAXS MEASUREMENTS

In testing the experimental layout and adjustment of the system, we used a dummy charge made of paraffin with a 6% additive of soot. The optimal adjustment corresponded to a SAXS signal from the dummy charge, which was approximately 3–5 times greater than the background noise.

Diffracted radiation was also registered under the given conditions, but its signal was two orders smaller than the SAXS signal. Therefore, the diffraction signal can be registered only with increasing intensity of the SR source or using detectors of much greater area. In experiments with HE, this component of radiation was not registered.

The first HE to be studied was the 50/50 TNT/RDX alloy. This alloy has the greatest output of UDD among the commonly used brisant HE [1]. The SAXS record is shown in Fig. 6 (curve 2). The SAXS signal starts to increase during compression in the detonation wave and continues for  $1.75 \text{ }\mu\text{sec}$ . The decrease lasts for hundreds of microseconds. The maximum value of the SAXS signal is 2–3 times greater than the signal from soot. The long-time growth of the SACS signal is of much interest, since it is assumed in accordance with the previous studies of explosive synthesis of UDD that diamonds are formed in a very narrow region of the detonation wave during a time of  $\approx 0.1 \text{ }\mu\text{sec}$  [1, 2]. One of the main reasons for this long-time growth of the SAXS signal during  $\approx 2 \text{ }\mu\text{sec}$ , apparently, is the increase in density fluctuations (“contrast range”) in the course of spreading of detonation products. The den-



**Fig. 10.** Comparison of the amplitudes of the measured SAXS signals (points 2) and that calculated with regard for the increase in the “contrast range” (points 3) for detonation of 50/50 TNT/RDX; points 1 refer to the signals from the detector of transmitted radiation.

sity of the condensed phase (including UDD) remains almost unchanged, and the density of spreading detonation products rapidly decreases.

If particles of mean size  $\delta$  and density  $\rho_0$  are uniformly located in a homogeneous medium of density  $\rho$ , then under the action of monochromatic radiation with the wavelength  $\lambda$ , the SAXS signal is

$$I(\lambda) = \alpha F(\delta, \lambda) G(\lambda) (\rho_0 - \rho)^2 N, \quad (1)$$

where  $\alpha$  is a dimensional coefficient,  $F(\delta, \lambda)$  is the shape factor depending on the particle size  $\delta$  and shape,  $G(\lambda)$  is the packing factor depending on the mutual positions of the particles, and  $N$  is the number of particles located within the path of the x-ray beam [3]. The total SAXS signal is obtained by summation over all wavelengths of radiation. It is seen from this formula that the value of  $(\rho_0 - \rho)^2$  increases with decreasing density  $\rho$  of detonation products during their spreading, since the density of crystalline particles  $\rho_0$  remains constant. Using the photographs of the explosion of a similar 50/50 TNT/RDX charge, which were made by the PIR-200 x-ray device, we evaluated the density  $\rho$  of detonation products in the course of their spreading. Figure 10 shows the measured SAXS signal (curve 2) and the SAXS signal calculated by formula (1) (curve 3). In calculating curve 3, it was assumed that all particles are formed in a narrow band behind the detonation front, i.e., the point  $F$  on curve 2 corresponds to the maximum number of crystalline particles. This point was chosen as the initial one for curve 3. Its further path is determined by the increase in  $(\rho_0 - \rho)^2 N$ . The char-

acteristic times of the increase and decrease of curve 3 almost coincide with the measured SAXS signal, and the amplitude is slightly lower. These facts do not lead to unambiguous conclusions; therefore, the authors believe that the issues of the growth time of crystalline particles and the behavior of SAXS signals remain open and require further study.

## CAPABILITIES AND PROSPECTS OF THE TECHNIQUE

We enumerate briefly the main parameters of detonation and shock-wave processes, which can be experimentally studied using synchrotron radiation.

First, this is the measurement of absorption of the direct beam and, hence, determination of the dynamics of the density of HE and detonation products. The use of a set (array and grid) of detectors (for example, a microstrip detector) oriented either along or across the detonation-propagation direction (charge axis) seems to be preferable. In the latter case, it is possible to determine the profiles of compression and expansion waves. In addition, the measurements of absorption of the direct beam can be used to study the reflection of shock waves, unloading (exhaustion of detonation products into vacuum or a given medium), and dynamics of motion of inert additives (powders). If markers absorbing SR (foil or compounds with good absorption of elements) are introduced into the HE, it is possible to study mass fluxes directly in the charge.

Second, registration of SAXS signals allows one to evaluate the dynamics of the total number of crystalline particles behind the detonation front in explosion. Using monochromatic radiation, it is possible to obtain a quantitative dependence of the number and size of particles on time. Instead of one detector, arrays of detectors should also be used. A significant limitation of this kind of experiments at present is the insufficient intensity of SR generated by VÉPP-3. One of the methods for increasing intensity is the use of a wiggler with more powerful magnets. The calculations show that the use of stronger magnetic fields in wigglers ( $B = 4$  T) increases the intensity of radiation of 30-keV x-rays by an order of magnitude (see Fig. 2).

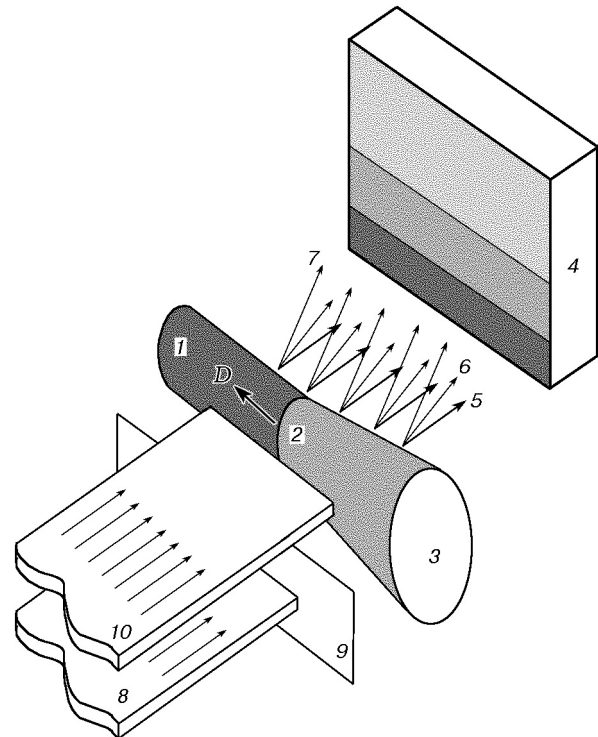
In the above experiments with one detector, the time resolution is determined by the period of revolution of electrons in the storage ring. For VÉPP-3, this time is 250 nsec. The storage ring may contain two bunches of electrons; in this case, the time between SR pulses is 125 nsec. In the VÉPP-4 accelerator, it is possible to obtain stable rotation of bunches with the minimum time between them  $\Delta t = 5$  nsec. For a deto-

nation rate  $D = 7.5$  km/sec, this time corresponds to a linear resolution  $X = 38$   $\mu\text{m}$ .

Another method of increasing the linear and time resolution is the use of devices with charge memory (linear and array charge-coupled devices, CCD). Information recorded in these devices is fed to the ADC consecutively, and it is sufficient to have only one registration channel in experiments. However, such a consecutive readout of signals from detectors increases the total time of information output from the CCD. This time is  $\approx 1\text{--}10$  msec; therefore, not all signals can be read during the period between SR pulses ( $\Delta t = 250$  nsec). After the next pulse, "overlapping" of signals and CCD overload occur. This limitation can be avoided by using a "parallel" scheme [4]. In this scheme, it is necessary to use correctors of the electron beam with a switch-on time of the order of 100 nsec. The field of correctors alters the trajectories of electrons and, hence, the position of the SR source. With appropriate adjustment, the radiation from each electron bunch can be directed to its own detector (or CCD). Since the registration system of each detector is completely independent, the requirement of the high performance of the "gauge-memory" system becomes less rigorous than in the case with the commonly used scheme. For example, the photographic film or the Image Plate may be used as detectors.

A "shock" system has been developed for VÉPP-3, which allows us to move rapidly the electron bunch from a stationary trajectory by  $\approx 20$  mm upward [4]. The "shock" system contains one more corrector (deflector), which allows us to return the bunch from the excited state to the main orbit. If we establish an array or line CCD along the HE charge so that radiation arrives there only if the electron bunch is shifted, we can obtain an instantaneous distribution of density with a linear resolution determined by the CCD cell size. For a cell of 15  $\mu\text{m}$  and detonation rate  $D = 7.5$  km/sec, the time resolution is 2 nsec. Figure 11 shows a possible layout of the experiment. If the electron beam moves along the main orbit, the initial SR beam hits the knife. As the beam orbit changes, the position of the SR source is also changed so that the radiation hits the HE charge under study. The synchronization system should provide transmission of the detonation front at the moment of arrival of the shifted SR pulse. As a result, transmitted radiation, SAXS signals, and diffracted radiation can be recorded on the array.

By using highly sensitive array CCD operating in the regime of x-ray spectrometers, it is possible to obtain the spatial distribution of diffracted photons with simultaneous determination of their energies for a local region of the charge at the moment of the "shock". This allows determination of instantaneous structures



**Fig. 11.** Layout of experiments with the "shock": 1) HE charge; 2) position of the detonation-wave front; 3) spreading detonation products; 4) CCD array; 5) record of transmitted radiation; 6) record of the SAXS signal; 7) record of the diffracted signal; 8) direction of the main SR beam; 9) knife shading the main SR beam; 10) SR beam shifted by the "shock."

and concentrations of crystalline inclusions in this region. Another method of registration of diffracted signals is the use of integrating detectors of large area with a high time resolution. Diffraction signals are registered at each SR pulse, similarly to SAXS signals in the conducted experiments. Registration of x-ray scattering at large angles allows one to study destruction and formation of various crystalline inclusions (melting and evaporation of HE crystals and metal particles, crystallization of solid oxides, etc.). In addition, the record of the diffraction pattern with a good resolution in terms of the angle and energy of x-ray quanta is helpful in identification of various crystalline phases and determination of their state (pressure, temperature, and particle size). If the HE contains elements of the middle part of the periodic table, comparatively isotropic x-ray fluorescent radiation is imposed onto diffracted radiation. The former is almost insensitive to the chemical composition of the re-radiating element and may be used to determine the dynamics of motion of various inclusions (and to determine mass velocities if markers are used).



The main limitation on such experiments is currently the insufficient intensity of diffracted radiation. This limitation may be avoided by using more powerful sources of synchrotron radiation.

This work was supported by the Russian Foundation for Fundamental Research (Grant Nos. 00-03-32521, 00-02-17641, and 01-02-18031), the Program for Leading Scientific Schools (Grant No. 00-15-96181), and the Program of integration fundamental research of the Siberian Division of the Russian Academy of Sciences (Grant No. 51).

## REFERENCES

1. V. M. Titov, V. F. Anisichkin, and I. Yu. Mal'kov, "Synthesis of ultradispersed diamond in detonation waves," *Fiz. Goreniya Vzryva*, **35**, No. 3, 117-126 (1989).
2. A. I. Lyamkin, E. A. Petrov, A. P. Ershov, et al., "Obtaining diamonds from explosives," *Dokl. Akad. Nauk SSSR*, **302**, No. 3, 611-614 (1988).
3. V. I. Iveronova and G. P. Revkevich, *Theory of X-Ray Scattering* [in Russian], Izd. Mosk. Univ., Moscow (1978).
4. S. A. Aleshaev, M. G. Fedotov, V. A. Mishnev, and B. P. Tolochko, "'Moving source': Test realization at VÉPP-3 of a diffraction experiment with nanosecond time resolution," *Nucl. Instr. Meth.*, **A448**, 234-240 (2000).